



ASSEMBLY INSTRUCTION
FRIAFIT® SEWAGE SYSTEM
FOR GRAVITY PIPELINES AND
HDPE PRESSURE PIPES

www.friafit.com

FRIAFIT® Sewage system

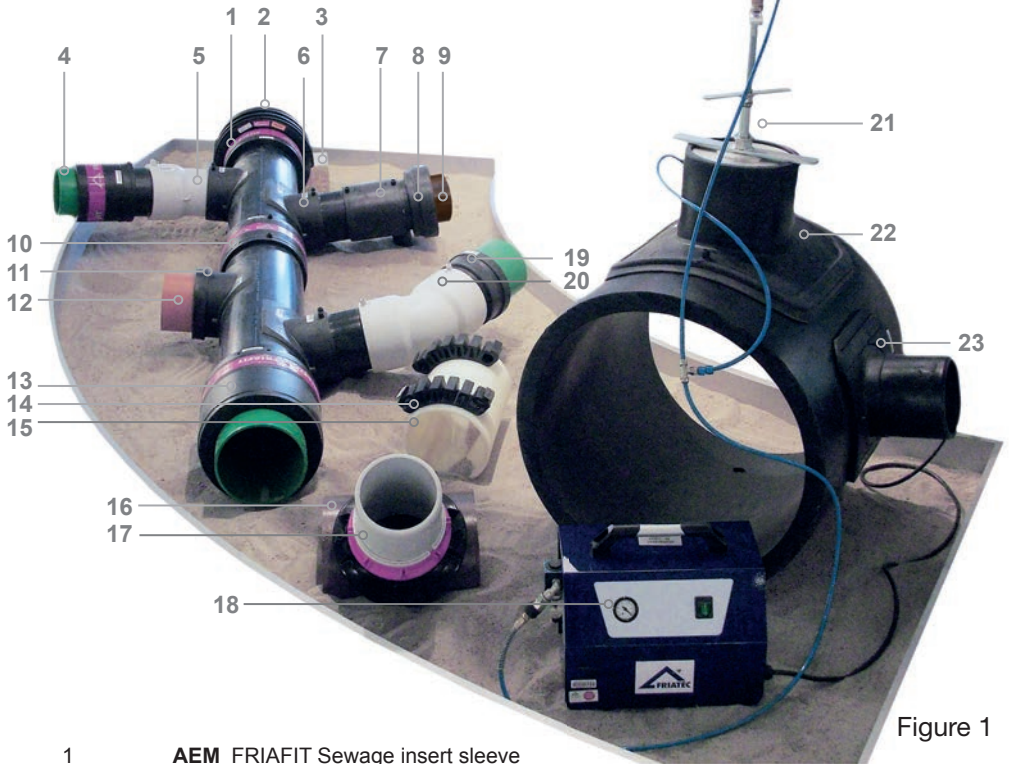

Figure 1

- 1 **AEM** FRIAFIT Sewage insert sleeve
- 2 **ASF** Sewage inspection chamber adapter
- 3 Concrete inspection chamber according to DIN 4034
- 4 PP pipe
- 5 **ABMS** Sewage bend 15°, 30°, 45° (coupler/pipe spigot)
- 6 **ASA TL** Sewage saddle
- 7 **AM** FRIAFIT coupler SDR 17
- 8 **USTZ** Transition fitting PE-Clay pipe
- 9 Clay pipe
- 10 **AM** FRIAFIT coupler SDR 17
- 11 **ASA TL KG** Transition saddle
- 12 PVC pipe
- 13 **AMKG** Transition fitting PE-PVC/PP
- 14 **FIXBLOC** Fixation for absorbing axial thrust and tensile forces
- 15 Close-Fit Liner
- 16 Clay or concrete pipe
- 17 **ASA MULTI** Connecting spigot to clay and concrete pipes
- 18 **VACUPUMP** Vacuum pump
- 19 **UKG** Transition fitting PE-PVC/PP
- 20 **ABM** Sewage bend 15°, 30°, 45° (coupler/coupler)
- 21 **PRESSKO** Plunger
- 22 **ASA VL** Sewage saddle Vacuum-Loading
- 23 **ASA UNI** Spigot saddle with outlet spigot SDR 17

Contents

FRIAFIT® Sewage system

	Page
1. Safety	4
2. Areas of application	4
3. Regulations and processing instructions	6
4. Fusing the FRIAFIT Coupler AM, UB SDR 17, Sewage bends ABM/ABMS and transition fitting AMKG	8
5. Installing the FRIAFIT Sewage inspection chamber adapter ASF into the concrete inspection chamber according to DIN 4034	19
6. Fitting the FRIAFIT Sewage insert sleeve AEM into the Inspection chamber adapter ASF/ASFL of the concrete inspection chamber	22
7. Fusing the FRIAFIT Sewage insert sleeve AEM d 110 – d 630 to the HDPE pipe	23
8. Fusing and tapping of a FRIAFIT Sewage saddle Top-Loading ASA TL and ASA TL KG	25
9. Installing the FRIAFIT sewage saddle vacuum loading ASA VL	35
10. Installing the FRIAFIT spigot saddle ASA UNI	42
11. Installing the FRIAFIT connecting spigot ASA MULTI	49
12. FRIAFIT Transition fittings UKG, USTZ, branches, sewage bends (spigot fittings) and transition fittings AMKG	54
13. Installing the FRIAFIT FIXBLOC	54
14. Updates of assembly instructions	63

For further information on the processing of FRIAFIT® Sewage system, please contact:

FRIATEC GmbH

Technical Plastics Division

P.O.B. 710261 · D-68222 Mannheim

Phone +49 621 486-2238

Fax +49 621 479196

Internet: www.friafit.com / e-mail: info-friafit@friatec.de



Hotline +49 621 486-1896

For a better readability, no identification by ® was used in the continuous texts of this assembly instruction.
The following brands are registered: FRIAFIT, FRIALEN, FRIAMAT and FRIATOOLS.

1. Safety

1.1 Safety advice and tips

The following warning symbols are used in these assembly instructions:

Symbol	Meaning
 DANGER	Danger to persons. Failing to observe this will cause death or serious injury.
 WARNING	Danger to persons. Failing to observe this can cause death or serious injury.
 CAUTION	Danger to persons. Failing to observe this can cause low to medium severity injuries.
NOTICE	Application tips and other useful information. Failing to observe this cannot cause injury.

2. Areas of application

The FRIAFIT Sewage system consists of fittings as well as the components/tools which are required for their processing for pipelines in the municipal drainage, in industry and in landfill construction.

The FRIAFIT Sewage system is used for the construction of gravity or pressure pipelines (according to component suitability), or for extension, repair or renovation of existing piping systems.

FRIAFIT coupler PE 100 SDR 17 are also suitable for usage in drinking water pipe systems up to an operating pressure of 10 bar.

On the basis of the electrofusion process, FRIAFIT fittings connect HDPE pipes longitudinally force-locked, root-proof, and permanently tight.

The FRIAFIT inspection chamber connection is used for concrete inspection chambers. The constructive design takes into account the different material properties of HDPE and concrete.

Saddle fittings enable a reliable connection between the main sewer and the house connection line.

The compact design of the sewage bends allows a space-saving installation with flexible routing of the pipeline, transition fittings provide a continuous material transition when the pipe material is changed.

NOTICE

The information and processing instructions mentioned on the fitting or enclosed shall apply predominantly, especially the permissible operating pressure.

2.1 Notice for non-buried pipes

This installation instruction describe primarily the technical requirements for ground-installed PE pipe systems. An extended field of application e.g. in industry, requires specific knowledge in planning, processing and installation.

In addition to the individual loading conditions, the specific requirements for project planning and execution have to be observed, e.g. according to DVS 2210-1 ff. for pipe systems in industry.

Deviations can lead to a reduced service life of the pipe system with a possible spontaneous failure, breakage or leakage.

An early failure may be caused by e.g.:

- Non-respect of minimum clearance of spigot saddles, e.g. ASA TL, ASA VL or ASA UNI with regard to the pipe diameter or its spacing to the next component.
- An overlapping of additional stress conditions in the case of open pipe installation, particular with regard to e.g.
 - Non stress free installation of the pipe system
 - Own weight
 - Fixed and loose bearing dimensioning and bearing friction
 - Changes of direction
 - Tensions caused by temperature oscillation or by wind
 - Dynamic loads caused by the operation of the pipeline
 - Vibrations in the area of influence of aggregates

3. Regulations and processing instructions

3.1 Standard conformity/fusability

The FRIAFIT Sewage system complies with EN 12666 and thus counts as a regulated building product. As such it does not require a general building supervision approval. A certificate of conformity from DIBt Berlin is available.

The FRIAFIT Sewage system (except couplers AM and UB SDR 17) can be fused to pipes of SDR grades 33 to 11, FRIAFIT Sewage bends ABM/ABMS and FRIAFIT transition fittings AMKG can be fused to pipes of SDR 33 to 17, in accordance with DIN 8074 and EN 12666.

FRIAFIT Couplers AM and UB SDR 17 are registered for the use in drinking water systems PN10 and industrial water systems. They have been registered according to DVGW GW335-B 2 using certification DV-8606B06114 and DV-8611B06115, and are subject to regular external checks.

FRIAFIT Couplers AM and UB SDR 17 can be fused to pipes of SDR grades 33 to 17 in accordance with DIN 8074, ISO 4437, EN 12201 and EN 12666. Other SDR ranges on request.

Please observe the guidelines of the DVGW regulations, of DVS, UVV respectively accident prevention regulations and the relevant country-specific regulations.

Pipes of material types **PE 63, PE 80, PE 100** and **PE 100 RC**. For PE-Pipes the Melt Flow Ratio MFR 190/5 shall be between 0.2 and 1.7 g/10min.

NOTICE

Fusing to other pipe materials e.g. PP, PVC etc. is not possible.

The FRIAFIT sewage system can be processed with FRIAMAT fusion units at ambient temperatures between -10 °C and +45 °C (except FRIAMAT L/LE/Geo). The temperature range to process FRIAFIT Couplers UB SDR 17 from d 710 is 0 °C to +45 °C.

NOTICE

During processing, pipes and fittings should have a balanced temperature level.

The FRIAFIT fittings can be stored and processed for a long time, provided the general storage specifications are adhered to.

Proper storage:

- in closed rooms or containers (boxes) and/or not exposed to UV radiation,
- not exposed to effects of weather such as humidity,
- storage temperatures between 0 °C and +50 °C.

If these requirements are met, a storage and processing period of more than ten years can be assumed.

NOTICE

Improperly stored component parts may not be processed because this may result in leaking fusion joints.

NOTICE

FRIAFIT Fittings are identified by a batch marking.

This reads from left to right:

- **Production week (KW) (stamp 1+2)**
- **Production year (stamp 2)**
- **Material identification letter (stamp 3)**

Some component parts are directly identified in reading direction.

Example:



KW 14/19/E

3.2 Pressure load-bearing capability

The FRIAFIT Sewage system has been designed for unpressurised pipes. The test pressure for this type of system in accordance with EN 1610 is a maximum of 0.5 bar.

In addition to this, FRIAFIT Coupler AM and UB made from PE 100 SDR 17 can be pressurised accordingly to EN 12201 up to a maximum of 10 bar for drinking water and sewage pressure pipes if the pipe is of suitable design (C = 1.25).

The FRIAFIT Sewage Bends ABM/ABMS and FRIAFIT Sewage Saddle Top-Loading ASA TL and ASA VL made of PE 100 SDR 17 are designed for a pressure load of 2.5 bar.

3.3 Static

The static calculation of the PE sewage pipe according to DWA-A 127 must be carried out by the appropriate pipe manufacturer or engineering company in each individual case in accordance with ambient conditions.

In any event, the ring stiffness of the pipe connection fused using FRIAFIT Fittings is higher than the ring stiffness of the inserted pipe.

NOTICE

The described sequence of the processes is absolutely to be adhered to.

4. Fusing the FRIAFIT Coupler AM, UB SDR 17, Sewage bends ABM/ABMS and transition fitting AMKG

4.1 Cutting to length of pipes

Cut off the pipe in a right angle to the pipe axis (see Figure 2).
A suitable tool is a saw with toothing suitable for plastics.

Pipe ends with distinctive conical cut ends have to be shortened, if necessary.

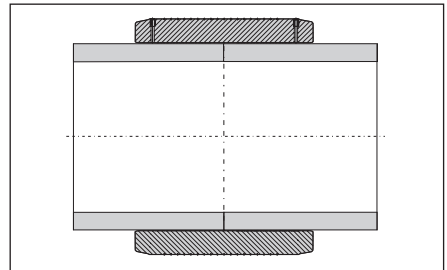

Figure 2

WARNING

A non-rectangular pipe cutting may cause the heating coil partially not being covered by the pipe which may result in overheating, uncontrolled melt formation or self-ignition (see Figure 3).

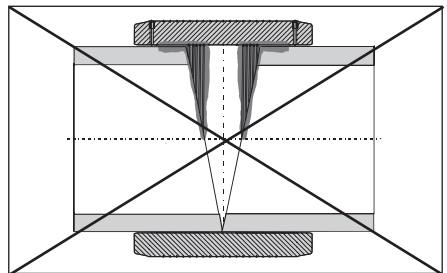

Figure 3

4.2 Measure fusion zone, mark with a marker and remove oxide layer (see Figure 4 and 6)



WARNING

Fusion with escaping media is not permissible.

FUSION ZONE:

On fittings, this is generally the insertion depth. i.e. the distance between the edge and centre of the coupler (see Figure 4).



Figure 4

At first, remove contaminations from the pipe. A processing allowance of approx. +5 mm in addition of the insertion depth provides proof after fusion that the oxide layer has been removed properly. Using a manual scraper or FRIATOOLS Scraper tool (see Figure 5), the oxide layer, which formed during on the surface of HDPE pipes and spigot fittings during storage, has to be removed completely directly before the assembly.



Figure 5

NOTICE

By using Scraper tools, like the FRIATOOLS scraper tools FWSG, a regular and complete dismantling of the oxide layer of the HDPE pipe is ensured (see Figure 6). Besides the increase of the working safety a faster processing is possible. Therefore, the use of scraper tools are mandatory.

For a control of the complete surface removal over the entire surface, we recommend to apply marking (control) lines. If during scraping of the surface non-scraped areas occur at some points (e.g. in case of oval pipes), these areas are to be reworked. The processed zone is to be protected against dirt, soap, grease, subsequently flowing water and unfavourable effects of weather (e.g. moisture, frost formation). Do not touch the fusion zone again after scraping.

The scraping result is to be verified.

NOTICE

If the oxide layer is not removed completely, inhomogeneous, leaking fusion joints may result.

A one-time, complete removal is sufficient (min. 0.15 mm). Damages to the pipe surface as e.g. axial grooves or scratches may not be located within the fusion zone.

NOTICE

An excessive swarf removal may result in an excessively large annular gap which either cannot or only insufficiently closed by fusion.

Please thus regularly check the condition of the blade at the manual scraper and the wear of the scraper blade at the scraper tool. Worn blades must be replaced!

Scraper tool	Desired swarf thickness (mm)	Wear limit (mm)
FWSG 63; SE	0.15 - 0.25	max. 0.3
FWSG 225; SE	0.25 - 0.35	max. 0.4
FWSG 710	0.30 - 0.40	max. 0.5
FWSG 900 L	0.30 - 0.40	max. 0.5
FWSG XL	0.40 - 0.60	max. 0.8

Table 1

The stated wear limit applies to FRIAFIT Fittings. Observe any manufacturer's instructions, if any!

Filing or sanding are not permitted because contaminations are introduced.

NOTICE

FRIAFIT Fittings with integrated heating coils guarantee optimal heat transfer through their exposed heating coils and may thus not be scraped at the inside of the fitting.



Figure 6

4.3 External and internal chamfering of the cutting edge (see Figure 7)

For this purpose, the manual scraper is a suitable tool. A chamfering of the pipe edge of the external diameter will make the coupler installation easier. **Remove swarves from within the pipe.**

4.4 Restoration of irregular / oval pipes

Pipes, especially those with larger diameters, can lose their roundness during storage. If the pipe out-of-roundness in the fusion zone area exceeds 1.5% of d (outer diameter) or is ≥ 3.0 mm, these pipes must be rounded in the fusion zone area. Please use rounding clamps for this purpose which are installed at the end of the fusion zone (see Figure 8). Like the hydraulic rounding clamp FWXRH.



Figure 7

Pipes with local deformation, like flattened areas, are not suitable for electrofusion.

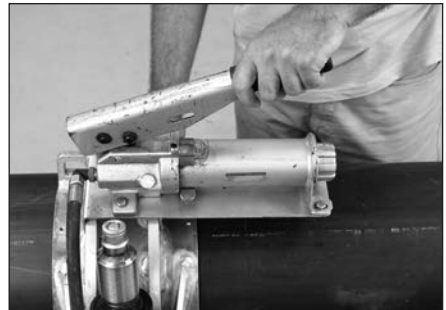

Figure 8

4.5. Cleaning

The surfaces of the pipes to be fused and the interior surfaces of the FRIAFIT Fittings must be absolutely clean, dry and free from any grease. These areas are to be cleaned with a suitable cleaning agent and **exclusively with absorbent, lint-free and non-dyed paper** directly before the assembly and after scraping (see Figure 9).



Figure 9

NOTICE

We recommend PE cleaning agents which meet the requirements of the test basis DVGW-VP 603, e.g. AHK cleaning agents.

When cleaning, ensure that no contaminations from the unscraped pipe surface are introduced into the fusion zone.

NOTICE

When using alcoholic cleaning agents, the alcohol percentage must be at least 99.8% according to DVGW-VP 603.

The amount of the cleaning agent is to be chosen such that the paper is slightly wetted. Skin contact is therefore to be avoided. Please observe the safety notes of the manufacturer!

The cleaning agent **must be completely evaporated** before starting the fusion process.

Subsequently, re-apply marking line for the insertion depth on the pipe distributed across the circumference (approx. 120°) with the FRIAFIT marker because this line was removed during scraping and cleaning. Take care to ensure that the fusion zones remain clean whilst doing this. It is essential not to touch the cleaned fusion zones with your hands (if necessary, clean zones again).

Moisture in the area of the joint area, e.g. because of dew or frost, is to be removed using suitable aids.

The fitting is to be removed from the packaging only directly before the planned processing. The packaging protects the fittings against external influences during transport and storage.

4.6 Positioning of insertion of pipe ends into the fitting

When the FRIAFIT Fitting and pipe are being assembled take care to ensure that the contact sockets are accessible to allow connection of the fusion plug.

Do not jam when connecting. The HDPE pipe must be able to be pushed into the FRIAFIT Fitting without force. Mounting can take place by applying blows at regular intervals around the frontal edge using a plastic hammer. The processed insert end must be inserted up to the marks distributed across the circumference. If necessary use rounding clamps (see Figure 8).

Because of the large tolerance ranges, a repeated scraping of the pipe diameter may be required. Repeated scraping may not be performed to remedy installation problems due to out-of-roundness.

If the coupler cannot be slipped on despite the above described procedure, a repeated scraping of the high points is permitted (see Item 4.4).

A simple control of the high points is possible by installing the fitting and evaluating the annular gap.

After assembly the annular gap between coupler and pipe should be checked. It is possible that **distortion** can occur due to storage, which may lead locally to large gaps between the pipe and the fitting. In this case it may be necessary to carry out additional work in order to re-round the pipes.

4.7 Ensuring a tension-free assembly of the components

All joints prepared for fusion must be tension-free. Pipes may not be positioned in the FRIAFIT Fitting under bending stress or self-load. (see Figure 10).

If necessary the pipe or the fitting has to be supported. The **annular gap** between coupler and pipe should be **clearly perceived to be uniform**.

Stress free support of the joint must be maintained until cooling time indicated by C.T. on the barcode is reached (see also Point 4.9)

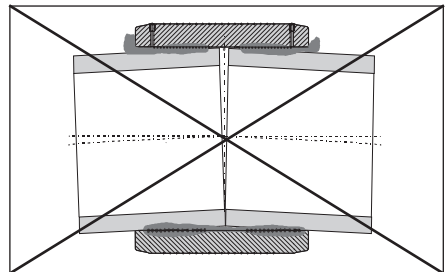

Figure 10

Before fusing, check once again the line marks and make sure that the pipe has not displaced in the FRIAFIT Fitting (correct, if necessary).

NOTICE

A non-tension-free or shifted joint may result in an impermissible melt flow and a defective joint during fusion (see Figure 10).

4.8 Carrying out fusion

(AM d 560 - AM d 630/UB SDR 17 d 710 - UB SDR 17 d 1200/AEM d 560 - AEM d 630 = see 4.8.1)

NOTICE

Use only fusion units which have been approved by the manufacturer with regard to their function for the processing of FRIAFIT Fittings. See DVS 2207-1. Please observe the operating instruction for FRIAMAT fusion units.

The fusion parameters are contained in a barcode which is affixed to each FRIAFIT Fitting. When using fully automatic fusion units (e.g. FRIAMAT fusion unit) the parameters are entered into the unit by using the wand or a scanner.

After reading of the barcode, the fitting data are to be compared with the data shown on the unit's display.

The fusable pipe series are listed in the SDR labelling on the label.

The fusion units automatically monitor the fusion process and control the supplied energy in determined limits.

HINWEIS

The fusion parameters are encoded on the barcode label in the form of a 24-digit figure (top), the data for component traceability in the form of a 26-digit column of numbers (bottom), and can also be entered manually into the FRIAMAT fusion unit using the emergency entry mode.



Figure 11

The subordinated barcode contains the data for component traceability. This barcode is only to be read if the component traceability function is to be used. This requires suitable fusion units. (see Figure 12).



Figure 12

Start fusion. Compare the instructions on the display with the data on the fittings. Avoid stress on the connecting spot.



Keep a distance of one meter to the fusion site during the fusion process for general safety reasons.

The obtained **ACTUAL fusion time** is to be compared with the **TARGET fusion time** on the unit and to be noted on the pipe or the FRIAFIT Fitting (see Figure 13).

With this identification it is ensured that no fusion point is overlooked.

When the fusion process is interrupted e.g. through generator failure, a fusion process may be repeated when both fitting and pipe have cooled down to the ambient temperature.



Figure 13

Please contact for this purpose your local FRIAFIT sales engineer by phone or the FRIAFIT Hotline: +49 621 486-1896.

 **CAUTION**

If fitting and pipe are not cooled down sufficiently there is the danger of overheating and spontaneous combustion.

HINWEIS

FRIAFIT Fittings from d 110 to d 450 and FRIAFIT Sewage Bends ABM have monofilar windings. With through winding, both sides of the fitting will be fused simultaneously (see Figure 14).

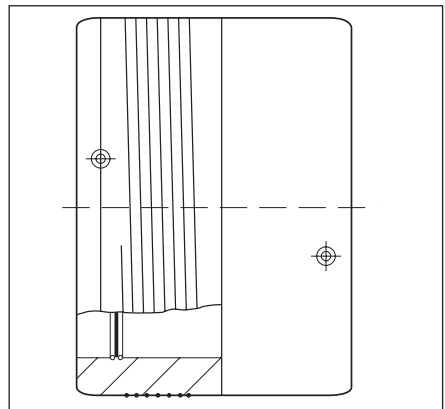

Figure 14

NOTICE

FRIAFIT Fittings AM from d 500 t d 630 and UB SDR 17 from d 710 to d 1200 have bifilar windings. If winding is separate, each side of the fitting needs to be fused separately (see Figure 15).

Immediately on completion of the fusion process, the next pre-mounted joint can be fused.

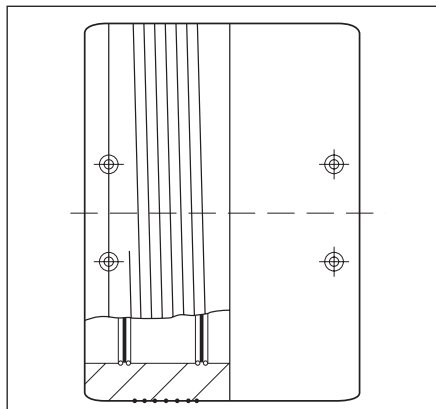

Figure 15

4.8.1 Indications for AM d 560 - d 630, UB SDR 17 d 710 - d 1200 and AEM d 560 + AEM d 630

For the safe bridging of the annular gap tolerances between pipe and coupler the preheating process **must be** carried out.

Preheating barcode for AM, UB SDR 17 and AEM \geq d 560 (see also instruction leaflet enclosed with the component part).

The ring gap between the coupler and the pipe can be compensated to a certain extent by using a specifically matched preheating barcode. The maximum bridgeable distance between the coupler and the pipe may not exceed 3 mm across the entire circumference. For the coupler mounted and centred at the pipe, this means: $d \leq 6$ mm. The thermal reduction of tensions in the joining area has also a positive effect on the fusion result.

Procedure:

1. Preparation of the area to be connected according to Point 4.1 - 4.8.
2. Place coupler in the centre of the pipe allowing for the annular gap to be spread as evenly as possible across the circumference. After centering the gap may not exceed 3 mm.
3. Close annular gap using adhesive tape in order to avoid loss of heat.
4. Close open pipe ends (chimney effect).
5. Standard processing:
 - I. Preheating of first coupler side, record yellow barcode with FRIAMAT electrofusion unit and start the process; then.
 - II. Preheating of second coupler side, record yellow barcode with FRIAMAT electrofusion unit and start the process; then.
 - III. First coupler side: check the ring gap: if it is still too large, the preheating can be repeated 2 x maximum. If ok: Start fusion of first coupler side, (white barcode), then.
 - IV. Second coupler side: check the ring gap: if it is still too large, the preheating can be repeated 2 x maximum. If ok: Start fusion of second coupler side, (white barcode).
6. Regard cooling times in line with Point 4.9.

NOTICE

Between preheating and fusion, a waiting time is always required to ensure heating through of the component parts. This waiting time corresponds approximately to the preheating or fusion time, depending on the dimension approx. 15-30 minutes. If only one coupler side is to be fused, the waiting time between preheating and fusion is to be observed. If the waiting time is exceeded by more than the double time, the described process is to be repeated.

NOTICE

Open pipe ends must be closed (chimney effect). If the weather is unfavourable (cold, wind), the annular gap can be closed using adhesive tape to avoid heat loss.

4.9 Cooling times

The cooling time is

- a) the time which is required to cool down the component to the temperature which facilitates the movement of the joint. This time is also listed on the barcode and is identified by CT.
- b) the time which is required to cool down the component to the temperature which facilitates the application of the full test or operating pressure.

NOTICE

For the insertion of pipings, the cooling time up to the application of pressure is decisive.

diameter in mm	cooling times in minutes for FRIAFIT Couplers AM and UB SDR 17	
	CT Until the joint may be moved, i.e. until operating pressure has been applied up to max. 0.5 bar (test pressure)	For the max. test pressure of a pressure pipe system PN 10
110	20	40
125 - 225	20	75
250 - 355	30	100
400 - 800	40	120
900 - 1200	90	240

NOTICE

The outer reinforcing wire detaching during the cooling phase is caused by heat induced expansion of the fused joint and is no negative aspect.

5. Installing the FRIAFIT Sewage inspection chamber adapter ASF into the concrete inspection chamber according to DIN 4034

Connections to structural items e.g. inspection chambers are to be implemented flexible according to DIN 4034 (or DWA - A 157). For this the ASF should be used in conjunction with the AEM (see Figure 1, page 2), as pipes made of HDPE will not form a joint with mortar or concrete.

The FRIAFIT Inspection chamber adapter ASF acts as a connecting element between the prefabricated inspection chamber and the FRIAFIT Sewage insert sleeve AEM. The ASF is usually fitted into the concrete when manufacturing the prefabricated concrete inspection chamber. Please make sure that the fixing bridges (T profile) are completely filled in the entire width.

The ASF is made to suit DIN 4034, (Concrete inspection chambers and prefabricated concrete components) i.e. it enables a flush connection (internal and external) in the bottom section of the concrete inspection chamber.

When vibrating in by machine the inspection chamber adapter must be supported by a core. The outside diameter of the core should be the same as the inside diameter of the ASF.

NOTICE

If the inspection chamber adapter is not supported during vibrating, this may lead to an ovalisation of the ASF which can in turn cause installation problems in connection with the AEM Sewage insert sleeve.

The ASF must be installed in the chamber with its “FRONT” face pointing to the outside.

NOTICE

When applying the ASF it is to be made certain that the correct positioning is ensured.

The gutter in the prefabricated concrete inspection chamber should be designed to be on the same level as the HDPE pipe (see Figure 17). See table 2, page 21 for the appropriate gutter heights (h) in accordance with the pipe wall thickness (s) of the PE pipe applied in each case. The gutter should connect flush to the ASF in the interior of the inspection chamber.



Figure 16

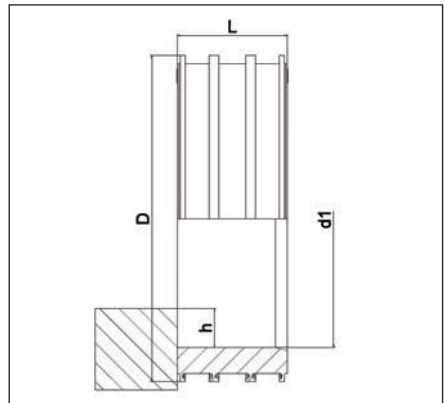

Figure 17

NOTICE

Depending on static conditions, the wall thickness of the applied PE pipe may vary. The wall thickness of the PE pipe applied must be requested from the client or engineering company, in order to avoid uneven gutter connections (step).

Alternatively an AEM with a piece of pipe pushed into it can serve as a template.

Example for HDPE pipe d 280x15.90 mm:

Wall thickness of the HDPE pipe (s) + wall thickness AEM = gutter height (h), starting from the ASF.

→15.90 mm + 16.50 mm = 32.40 mm

If you require further information on the installation of the ASF, please contact our FRIAFIT customer service, Tel No +49 621 486-1896.

Table 2:

d mm mm	Gutter height (h) ASF in mm			
	SDR 33	SDR 26	SDR 17,6	SDR 17
110	14.0	14.8	16.8	17.1
160	18.5	19.7	22.6	23.0
180	23.1	24.5	27.7	28.2
200	29.7	31.2	34.9	35.4
225	33.0	34.7	38.8	39.4
250	21.3	23.2	27.7	28.3
280	25.2	27.3	32.4	33.1
315	29.3	31.7	37.4	38.2
355	33.1	36.7	42.1	43.1
400	36.9	39.9	47.2	48.2
450	38.5	41.9	50.0	51.2
500	43.8	47.6	56.9	58.2
560	50.2	54.4	64.7	66.2
630	57.3	62.1	73.7	75.4

- d - external pipe diameter
- s - wall thickness of the HDPE pipe
- ID - internal diameter of the HDPE pipe
- h - gutter height, starting from the ASF.

6. Fitting the FRIAFIT Sewage insert sleeve AEM into the Inspection chamber adapter ASF/ASFL of the concrete inspection chamber

The AEM (see **Figure 1, page 2**) is used for the flexible connection of HDPE pipes into the ASF inspection chamber adapter. Before connecting the AEM into the ASF, the following points should be observed:

6.1 Preparation

Clean the inner surface of the ASF, and then thinly apply **soft soap based lubricant**.

NOTICE

Oils and grease are not suitable as lubricants. Keep the areas to be fused free from contamination caused by lubricant!

Remove AEM from foil bag. Check correct position of sealing rings (**2 pieces**). It is a water swelling sealing ring Q (blue) enclosed. It would need to be positioned into the appropriate AEM nut before insertion into the ASF.

NOTICE

The water swelling sealing ring Q is protected from wet and moisture inside a foil bag. Take out and position on the AEM only immediately prior to mounting.



Figure 18

6.2 Assembling the AEM

The AEM is then pushed with its sealing rings first into the ASF. This process is either carried out by hand or using a crow bar with a piece of wood laid across the front of it (see Figure 19).

The AEM must be pushed in until it connects flush with the ASF / ASFL (see Figures 20a / 20b).

NOTICE

Heating coils must be protected against damage and dirt while the AEM is being inserted.



Figure 19

7. Fusing the FRIAFIT Sewage insert sleeve AEM d 110 – d 630 to the HDPE pipe

7.1 Cutting to length of pipes (see 4.1)

7.2 Measure the fusion zone, mark it with a FRIAFIT marker and remove the oxide layer.

a) ASF fusion zone use

Insert the pipe into the AEM until it lies flush with the AEM's face side directly adjoining the channel (see Figure 20a).

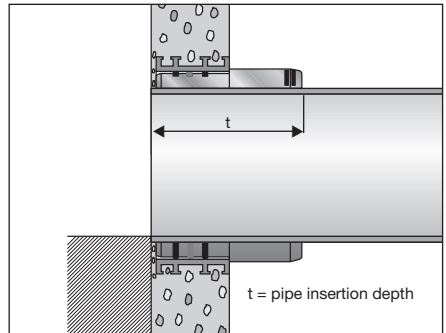

Figure 20a

b) ASFL fusion zone use

The pipe is pushed into the AEM until it is connected directly to the gutter (see Figure 20b).

Further proceeding as described under 4.2.

7.3. External and internal chamfering of the cutting edge

as described under 4.3

7.4. Restoration of irregular / oval pipes

as described under 4.4

7.5. Cleaning

as described under 4.5

7.6. Inserting pipe ends into the sleeve

It has to be ensured that the pipe can be pushed into the FRIAFIT Sewage insert sleeve AEM without force. **The processed insert end must be inserted up to the mark or up to the channel (see Figures 20a+b). Do not tilt when joining together!**

Additional points as described under 4.6.

7.7. Ensuring a tension-free assembly of the components

as described under 4.7

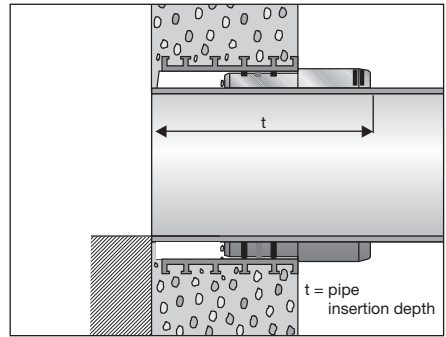

Figure 20b

NOTICE
A non-tension-free or shifted joint may result in an impermissible melt flow and a defective joint during fusion (see Figure 21).

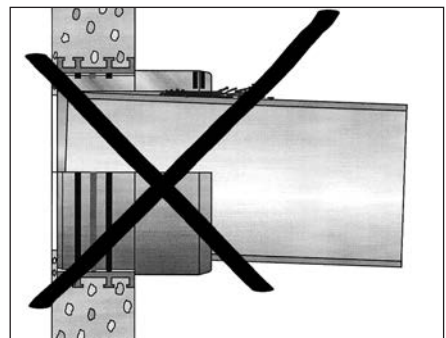

Figure 21

7.8 Carrying out fusion

as described under 4.8

for AEM d 560/AEM d 630 as described in 4.8.1

7.9. Cooling times

see Point 4.9

Diameter in mm	Cooling times in minutes for FRIAFIT AEM Sewage insert sleeves
	CT Until the joint may be moved, and until pressure of max. 0.5 bar (test pressure) is applied respectively.
110	10
160 - 225	20
250 - 355	30
400 - 630	40

8. Fusing and tapping of a FRIAFIT Sewage saddle Top-Loading ASA TL and ASA TL KG

With the FRIAFIT Sewage saddle sewage house connections can be connected to the main pipe made of HDPE with the dimensions SDR 33 to SDR 11.

Areas of application: new installations or retrospective integrations of domestic connections.

NOTICE



Make sure before starting work that you have the following tools and equipment in perfect working order:

- FRIATOOLS clamping and drilling unit FWFIT
- If necessary, clamping belt (see table 3, page 26)
- If necessary, additional FRIATOOLS clamping unit FRIATOP (see table 3, page 26)
- Drilling machine with drilling template (equipment FWFIT) and drill d 12.5 mm (equipment FWFIT)
- Standard fusion equipment

Processing hint:

Please observe to use the correct clamping tool according to the table 3 on page 26!

Table 3:

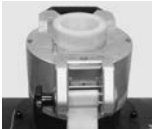
ASA TL	pipe-dimension	HDPE pipe SDR		O Standard application FWFIT clamping and drilling unit	
		SDR 26-33	SDR 11-17.6		
d 200/160	d 200	OX	OX	O	
d 225/160	d 225	OX	O		
d 225/160	d 250	OΔ	OΔ		
d 280/160	d 280	OX	O	OX In addition: Clamping belt required. Do not clamp ASA TL over star handle.	
d 315/160	d 315	OX	O		
d 355/160	d 355	O	O		
d 400/160	d 400	O	O		
d 450/160	d 450	O	O		
d 500/160	d 500	O	O		
d 500/160	d 560	OΔ	OΔ		
d 500/160	d 630	Please contact our application engineering department		OΔ In addition: FRIATOP clamping unit required	
For the assembling to Close-Fit-Liner and pipes d 630 please contact our application engineering department on tel.: +49 (0)621 486-1896					

NOTICE

If a pipe d 560 is used, the FRIAFIT Sewage saddle d 500/560 is clamped with the FRIATOP Clamping unit (see item 8.6.3).

NOTICE

If a pipe d 250 is used, the FRIAFIT Sewage saddle d 225/160 is clamped with the FRIATOP Clamping unit.

NOTICE

The described sequence of the processes is absolutely to be adhered to.

8.1 Measuring the fusion zone on the pipe and mark with a FRIAFIT marker

Fusion zone is the area of pipe covered by the saddle.

Place ASA TL on the intended spot of the service line on the main pipe (see Figure 22).



Figure 22

8.2 Marking the insertion bores using the drilling template

The drilling template (FWFIT accessories) serves for the marking of the insertion bores for the clamping core (centre) and the FWFIT cutter. Insert drilling template axially to the longitudinal axis of the main pipe into the outlet of the ASA TL and mark insertion bores using the FRIAFIT marker (see Figure 23).



Figure 23

8.3 Preboring

Remove ASA TL and drilling template. Drill centre bore and cutter insertion bore using a **d 12.5 mm** drill (FWFIT accessories). Use a cordless drill machine (see Figure 24).

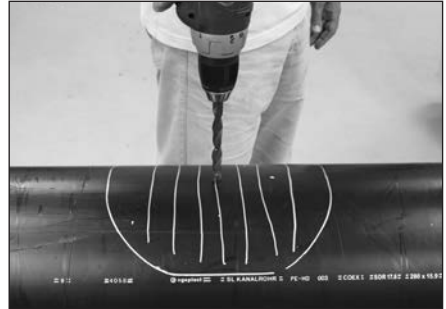

Figure 24

NOTICE

For drilling the centre bore and the cutter insertion bore drills of **d 12.5 mm** must always be used.

NOTICE

Please take care that the borings are carried out each time right-angled to the indicated surface of the pipe (see Figure 24). When tapping, do not insert the drill repeatedly into the hole.

NOTICE

The number of revolutions of the cordless drill must amount to a minimum of **900 revolutions/minute**.

8.4 Removing oxide

Directly before installation, you must use a manual scraper or scraper tool FWSG SE to remove completely the oxide layer at the fusion zone that has formed during storage on the pipe surface.

NOTICE

If the oxide layer is not removed completely, leaking fusion joints may result.

Worn blades of the manual scraper must be replaced.

A one-time, complete removal is sufficient (min. 0.15 mm). A uniform surface without flattening and material grates at the pipe diameter should be the result.

NOTICE

Filing or sanding of the pipe is not permitted because contaminations are introduced.

For a control of the complete surface removal over the entire surface, we recommend to apply marking (control) lines (see **Figure 25**). If during scraping of the surface non-scraped areas occur at some points, these areas are to be reworked. The processed zone is to be protected against dirt, soap, grease, subsequently flowing water and unfavourable effects of weather (e.g. moisture, frost formation).

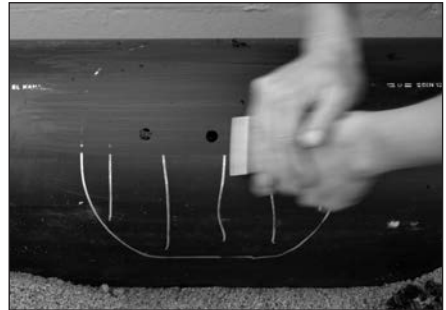

Figure 25

8.5 Cleaning

See Point 4.5 (see Figure 26) on cleaning the scraped pipe surface and the inside of the saddle.

8.6 Assembling the ASA TL

8.6.1 Processing using FWFIT

Attach the three handles (FWFIT accessories) to the cross beam of the FWFIT clamping and drilling unit.

Place saddle onto the prepared pipe surface and align along the **central bore** (see Figure 27).



Figure 26



Figure 27

NOTICE

When installing side-on it is necessary to ensure that the barcodes for fusing the ASA TL or the contact sockets at the outlet are visible from above.

Place FWFIT **without** cutter unit on the outlet of the saddle and insert clamping core into centre bore (see Figure 28).



Figure 28

NOTICE

Make sure that the heating coils in the outlet are not damaged. The supporting faces of the cross beam must fit flush to the upper edge of the saddle outlet.

Do not tilt when inserting the clamping core into the central bore!

Clamp clamping core right **to the end** by turning the star handle clockwise. **The directions are marked on the cross beam as “AUF” (open) and “ZU” (close).** While tightening, press the star wheel towards the pipe.

Check visually the supporting face of the saddle on the pipe. The saddle must fit tight in its flanks and onto the pipe’s apex.

8.6.2 Processing using FWFIT and clamping belt

NOTICE

ASA TL d 225, d 250, d 280 and d 315 must be mounted to pipes SDR 26 to SDR 33 with clamping belt. ASA TL d 200 is always, i.e. for pipes from SDR 11 to SDR 33, to be mounted with clamping belt.

Procedure:

- Mount FWFIT but do not tighten star handle!
- Wind clamping belt around pipe.
- Align girder in such a way that the hooks of the clamping belt may be hooked into the blind hole boreholes of the girder.
- Clamp belt manually and tighten by turning the belt ratchet until the ASA TL saddle sits flush on the pipe **(see Figure 29).**



Figure 29

Fusion of the saddle takes place according to Point 8.7.

8.6.3 Processing using FRIATOP

With pipes d 250 and d 560 the ASA TL d 225 respectively d 500 is mounted using the FRIATOP **(see Figure 30)** clamping unit. Please observe FRIATOP assembly instructions. The clamping pressure on the pressure gauge of the air pump should not exceed 2 bar. Fusion of saddle takes place according to Point 8.7.

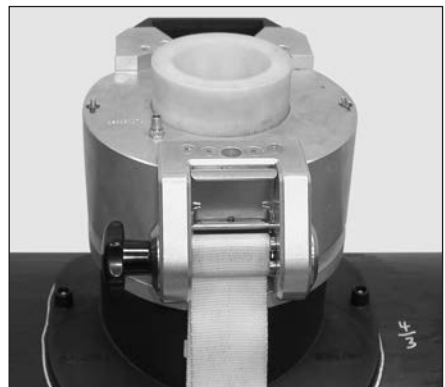

Figure 30

8.7 Fusing of the saddle

NOTICE

Only use fusion units which are authorised by their manufacturer to process FRIAFIT Sewage saddles (FRIAMAT Fusion units except FRIAMAT L/LE). See DVS 2207, part 1, 5.2.



Figure 31

The fusion parameters are contained in a barcode which is attached to the FRIAFIT Sewage saddle (see Figure 31).

The parameters are entered into the fusion unit via a wand or scanner.

The fusion unit automatically controls the fusion procedure and adjusts the energy supply within given limits.

Start the fusion process. Information in the display of the fusion unit must be compared with the fitting data.

CAUTION

Always keep one meter distance to the fusion site during fusion for general safety reasons.

The **ACTUAL fusion** time must be compared with the **TARGET fusion** time on the unit and marked on the pipe.

8.8 Cooling times

Cooling time is the time required to cool the component down to the temperature needed to enable tapping into the main pipe. This period of time is contained in the barcode and is marked as C.T.

Diameter in mm	Cooling times in min. for FRIAFIT Sewage saddle ASA TL and ASA TL KG CT until tapping
200 - 630	10

NOTICE

If the cooling time is not observed the saddle may become separated from the pipe in the fusion zone. A permanently secure joint cannot be guaranteed. The clamping and drilling unit may not be dismantled or loosened during the cooling time!

8.9 Tapping

Tapping of the main pipe is carried out with the FWFIT clamping and drilling unit as well.

Loosen the star handle of the FWFIT until the cross beam may be easily turned. Position the cutter insertion in the cross beam above the boring, then insert cutter unit into the cross beam up to the stop. The cutter must fit into the boring (see **Figure 32**).



Figure 32



WARNING

Do not touch the outlet during operation (rotating tool).

NOTICE

When inserting the cutter, take care that the heating coil or elastomer sealing of the ASA TL KG in the outlet is not damaged.

Place cordless drill machine onto cutter unit and clamp boring socket.

NOTICE

The number of revolutions of the cordless drill must amount to a minimum of 900 revolutions/minute.

The outlet of the main pipe created by cutting **clockwise**. Hold the cordless drill machine with one hand, and at the same time guide the cross beam by the handles provided using the other hand (see **Figure 33**). If necessary, remove swarf in the outlet.

NOTICE

Too much expenditure of force during the cutting process may lead to premature wear of the cutter, to deviations from the desired cutting path and to breakage of the cutter respectively.



Figure 33

After completing the cutting process, run **several times** across the starting point (short twist of cross beam to the right and to the left).

Once the drill has stopped, release the drill chuck and remove the drilling machine. Then dismantle the FWFIT.

NOTICE

When removing the FWFIT, take care that the heating coil or elastomer sealing of the ASA TL KG in the outlet is not damaged by the cut-out circular disk.

Take out the cutter unit from the FWFIT, loosen star handle (**direction is marked on the cross beam as “AUF” (open)**) and pull off circular cutted piece from the clamping core. Store the FWFIT in its transporting case.

8.10 Clean cut-out drill-hole

Remove the swarf in the ASA TL outlet.

8.11 Fusing the ASA TL outlet

- Follow the described processing steps in sections 4.1 - 4.9

8.12 Slip-on couplers of the ASA TL KG

The slip-on coupler is suitable for transition connections of PVC and PP pipes DN 150.

For the material transition, the specific standards, e.g. with regard to the permissible diameter tolerances and insertion depths, as well as the mounting instructions are to be observed.

After tapping of the main pipe, the swarves in the plug-in outlet of the ASA TL KG are to be removed and anti-seize agent on soft soap basis is to be applied thinly.

Cut the PVC or PP pipe clean and straight. Chamfer the cut pipe edge on the outside.

Remove swarves and dirt from the pipe with a dry and clean paper.

Mark the insertion depth of the slip-on coupler with a line on the pipe.

Insert the pipe into the slip-on coupler up to the stop.

9. Installing the FRIAFIT sewage saddle vacuum loading ASA VL

The FRIAFIT sewage saddle ASA VL can be used to connect d 225 / DN 200 PE pipes to HDPE sewage drains (SDR 33 to SDR 11).

NOTICE

Make sure before starting work that you have the following tools and equipment in perfect working order:

- FRIATOOLS vacuum pump VACUPUMP (see Fig 34b) or FRIATOOLS VACUSET XL (see Fig 34a)
- FRIATOOLS plunger PRESSKO (see Fig 35)
- FRIATOOLS tapping kit FWAB ASA (see Fig 40)
- **Also needed: compressor for usage VACUSET XL, drilling machine, and standard fusion equipment**

The VACUSET XL or the VACUPUMP is designed for a temperature range of -10 to +45 °C and a max altitude of 1000 m. Please contact our application engineering department for other environments, tel.: +49 621 486-1896.

A compressor or vacuum pump is needed to generate the vacuum. Please consult the FRIATOOLS operating instructions VACUSET XL or VACUPUMP for the technical requirements.

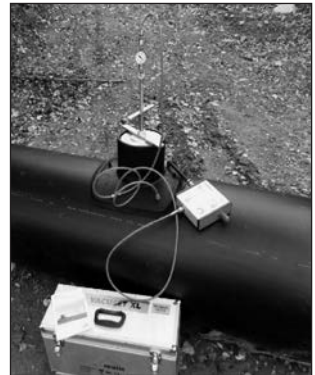

Figure 34a



Figure 34b

NOTICE

Consult the compressor respectively generator manufacturer's details for the permitted working range, i.e. operating temperatures or the power range.

The FRIATOOLS tapping kit FWAB ASA (see Figure 40) is designed for tapping unpressurised lines.

9.1 Installation

Prepare for fusion by following the steps analogously for the FRIAFIT sewage saddle ASA TL (see Sections 8.4 – 8.5).

NOTICE

The vacuum clamping technology is installed in accordance with the operating instructions for the FRIATOOLS VACUSET XL or VACUPUMP.

Place the FRIAFIT sewage saddle ASA VL with the saddle on a clean surface, e.g. on a cardboard box, and install the equipment as described in the following.

- Insert the FRIATOOLS plunger PRESSKO (order no. 613823) in the tap off spigot to the stop on the crossbar, and seal the pipe spigot (see Figure 35). Engage and disengage the plunger by turning the hand lever as described in the PRESSKO operating instructions.
- Connect the vacuum lines (see Figure 36).
- Switch on the compressor respectively the generator.

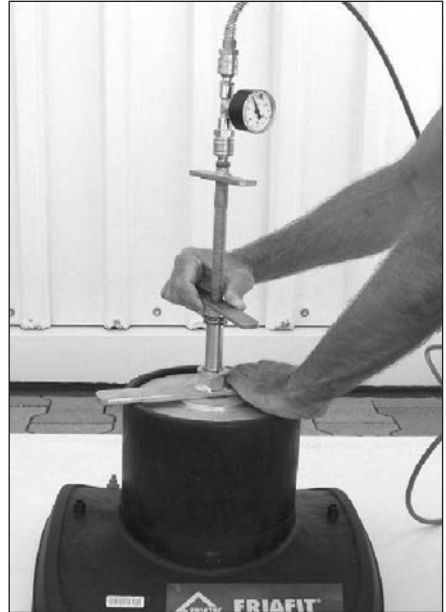

Figure 35



Figure 36

NOTICE

Check that each component functions correctly, in particular the sealing properties of the hose connections and, if necessary, the fuel levels in the generator and compressor.

- Place the FRIAFIT sewage saddle ASA VL on the processed pipe surface, and press against the saddle until it sits securely on the pipe under the action of vacuum (**see Figure 37**).
- Make sure that the FRIAFIT sewage saddle ASA VL has been positioned correctly.
- For the entire duration of this process (approx 15 min) until the end of the cooling time, the vacuum must be at least 0.8 bar, i.e. less than 0.2 bar absolute (**see Figure 38**).
- Start fusion (**see Figure 39**).
- Afterwards, note down the fusion time on the pipe or fitting. The fusion plugs can be removed after the fusion time.
- After fusion, observe a 10 min cooling time with the device still clamped under the action of vacuum.
- Check the proper functioning of the processing according to the specifications.
- Remove the vacuum lines and the plunger.



Figure 37



Figure 38



Figure 39

9.2 Tapping

The pipe is tapped with the FRIATOOLS tapping kit FWAB ASA (see Figure 40). Proceed in accordance with the operating instructions for the FRIATOOLS tapping kit FWAB.



Figure 40

Special tapping equipment is required for tapping pressurised pipes. Please contact first our application engineering department on tel. +49 (621) 486-1896. The following cooling times must be observed:

Diameter in mm	Cooling time in min for FRIAFIT sewage saddle ASA VL	
	From end of fusion to tapping (clamped under vacuum)	Until pressurisation up to max 2.5 bar
315 - 710	10 min	10 min

The cooling time CT specified on the components corresponds to the minimum cooling time until tapping.

NOTICE

Observe the FRIATOOLS operating instructions for the tapping kit FWAB ASA!



Danger of explosion!

There must be no explosive mixtures (e.g. residual or sewage gases) in the pipe while it is being tapped.

NOTICE

Unpressurised (open) conduits with medium:

Make sure that the whole tap is above the level in the pipe. If necessary, the pipe must be disconnected from the network.



Danger from electric shock!

Tapping could cause the medium to flow directly into the drilling machine.

9.3 Fitting the connecting line

Use a FRIAFIT coupler AM d 225 or transition fitting AMKG d 225 to connect the PE line to the outlet spigot on the FRIAFIT ASA VL.

Please observe the processing instructions under Section 4.

9.4 Installation for multidimensional processing

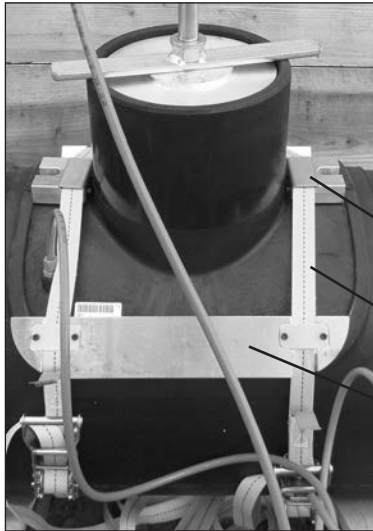

To install the FRIAFIT Sewage Saddle Vacuum-Loading ASA VL for multidimensional processing, the ASA VL mounting aid (see **Figure 41**) is required in addition to the standard installation tools.

Securing block

Tensioning belt

Clamping bar

The ASA VL can be used on the following pipe dimensions (see **Table 4**):

Figure 41

Table 4:

d_{pipe}	ASA VL d_1/d_2	SDR _{pipe}
315	355/225	33 - 11
400	355/225	33 - 11
500	450/225	33 - 11
710	630/225	33 - 11

NOTICE

ASA VL d 355/225 on pipe d 315 is only designed for ambient temperatures ranging from +5 °C to +45 °C.

- To install the ASA VL on the pipe, use the ASA VL mounting aid (order no. 613371) in addition to the VACUSET XL (see Figure 42).
- First fit the ASA VL mounting aid. Make sure the mounting aid sits correctly on the saddle.
- Position the securing block on the ASA VL in such a way that the contact pins are freely accessible (see Figure 43).



Figure 42

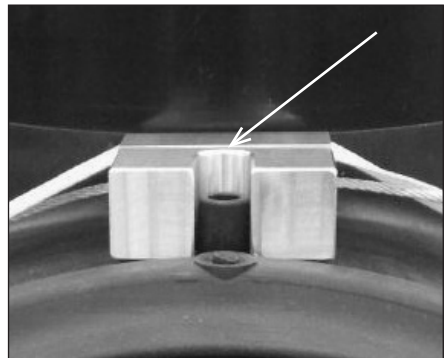

Figure 43

- Next, place the tensioning belt with the clamping bar around the saddle. Because of the defined position of the clamping bar on the tensioning belt, the clamping bar is automatically positioned on the edge of the saddle (**see Figure 44**). If necessary, manually correct the position of the clamping bar.



Figure 44

- Loop the tensioning belt around the pipe and pass the end of the tensioning belt into the belt ratchet.
- Tighten the ASA VL firmly onto the pipe by operating the belt ratchet.
- Carry out the steps described in section 9.1 Installation.
- Note the vacuum information from section 9.1.
- Connect up the fusion contacts (**see Figure 45**).
- Read the preheating barcode (printed on the instruction leaflet) into the fusion unit (**see Figure 46**) and then start the preheating process.
- Start fusion immediately once the preheating process ends.
- Continue as described in sections 9.1 (from the step “note down the fusion time”) to 9.3. At the end of the cooling time, release the belt from the belt ratchet and remove the ASA VL mounting aid.



Figure 45



Figure 46

10. Installing the FRIAFIT spigot saddle ASA UNI

The FRIAFIT spigot saddle ASA UNI can be used to connect PE pipes to branch lines, without pressure or pressurised pipes. The spigot outlet d 160 offers a sole-like passage by using pipes with SDR 17/17.6.

NOTICE

Make sure before starting work that you have the following tools and equipment in perfect working order:

- FRIATOOLS clamping unit UNITOP
- Adapter for tap off spigot d 160 (Order-Ref. 613839)
- FRIATOOLS drilling device FWAB ASA (Order-Ref. 613838)
- Cordless drilling machine and standard fusion equipment

10.1 Preinstall the saddle on the pipe

Position the clamping plate on the spigot saddle ASA UNI (see Figure 47).

NOTICE

Make sure that the spigot saddle ASA UNI is supported on a clean and dry base (see Figure 47).

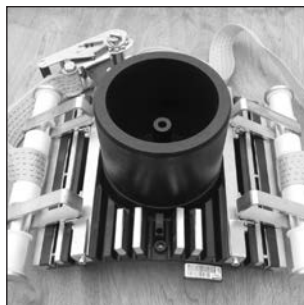

Figure 47

Position the spigot saddle ASA UNI together with the preinstalled clamping plate on the prepared pipe surface (see Figure 48).

CAUTION

Make sure that the ratchet is used properly and that the bottom belt is threaded through properly.

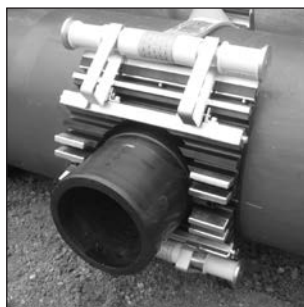

Figure 48

The bottom belt is fixed to the clamping bar of the clamping plate. Loop the bottom belt round the pipe, insert the loose end of the bottom belt into the belt ratchet. Operate the belt ratchet to position the clamping plate with the spigot saddle ASA UNI on the pipe.

NOTICE

Use the ratchet to tighten the bottom belt until it is handtight! The spigot saddle ASA UNI is pre-fitted first, clamping does not occur until the next step.

NOTICE

Make sure that the bottom belt is not twisted and that it is positioned centrally within the guides of the clamping bar.

CAUTION

Risk of injury! Once the installation is complete, the clamping lever of the ratchet must be locked in a closed position (see Figure 49).



Figure 49

10.2 Installing the clamping unit

NOTICE

Before installing the clamping unit make sure that the crossbar of the clamping unit is in its end position (see Figure 50).

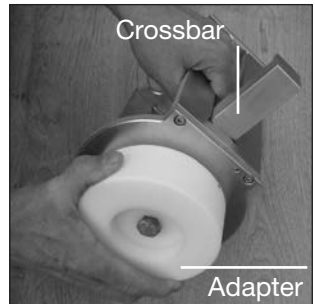

Figure 50

Select the appropriate adapter for the outlet spigots of the spigot saddle ASA UNI and screw the adapter onto the clamping unit (see Figure 50).

INFORMATION

The adapter for ASA UNI with tap off spigot d 160 is not in scope of delivery and has to be ordered separately (Order Ref. 613839)

Table 5: Applications of the upper clamping belt

FRIAFIT spigot saddle ASA UNI for the main line	Colour of the upper clamping belt
d_1	
630 - 900	Red

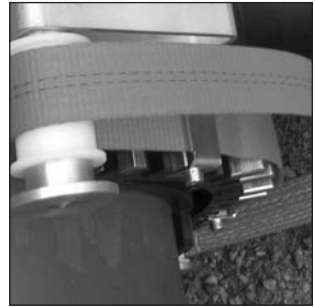

Figure 51

Select the upper clamping belt in accordance with the dimension range (**Table 5**) and thread both clamping belts onto the positioning points of the clamping bar of the clamping plate (**see Figure 51**).

Fit the clamping unit onto the outlet spigot of the spigot saddle ASA UNI.

- To do this insert the adapter into the outlet spigot of the spigot saddle ASA UNI (**see Figure 52**).



Figure 52

- Hold the clamping unit firmly in this position and place both clamping belts round the crossbar, so that the clamping unit, clamping plate and spigot saddle ASA UNI are positioned firmly on the pipe (**see Figure 53**).



Figure 53

- Make sure that the UNITOP clamping unit, the ASA UNI spigot saddle, and the clamping belt are aligned at right angle and are straight (see Figure 54). If necessary, correct the position of the spigot saddle on the pipe.

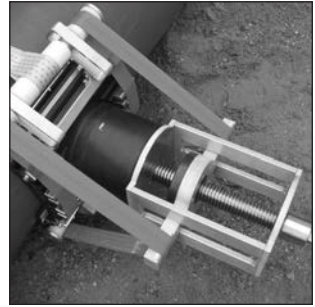

Figure 54

CAUTION

If necessary, secure the position of the ASA UNI spigot saddle against unintentional slipping.

NOTICE

Make sure that the clamping belts are positioned centrally with the guides of the clamping bar on the clamping plate and on the crossbar on the clamping unit (see Figure 55)!

NOTICE

Do not twist the belts!

NOTICE

After installing the clamping unit UNITOP on the pipe, check again the correct position of the spigot saddle ASA UNI!

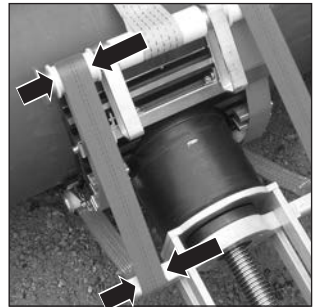

Figure 55

10.3 Operating the clamping unit

CAUTION

Risk of crushing! Do not reach under the clamping plate or the saddle component when the clamping unit is being operated.

NOTICE

Do not put any extension device onto the ratchet as this could cause damage to the device.

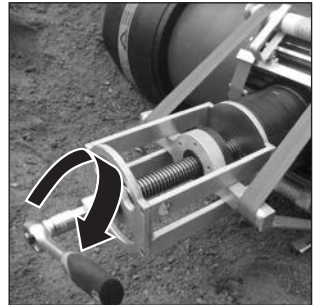

Figure 56

Clamp the ASA UNI spigot saddle onto the pipe.

To do this, put the ratchet with the nut onto the flat of the threaded spindle and turn it in a clockwise direction (see **Figure 56**) until the ASA UNI spigot saddle is supported on the pipe surface, with no gaps (see **Figure 57**).

CAUTION

The belts are under tension!
Belt failure may cause injury.



Figure 57

NOTICE

Pay attention during the installation that the electric contact pins of the spigot saddle ASA UNI are placed permanently in the designated pocket of the clamping plate (see **Figure 57**).

Remove the ratchet and put it back to the transport box.

10.4 Carrying out of fusion

NOTICE

Check the alignment of the device and correct, if necessary. Also check that the saddle is positioned on the pipe, with no gaps! It may be necessary to re-tension the saddle.



Figure 58

Carry out the fusion (see Figure 58).

NOTICE

If your fusion unit is fitted with straight fusion plugs, you will also need the angle adapter ADWL (Order Ref. 613241). FRIAMAT fusion units are already fitted with angle plugs. If you have any questions, please contact our application engineering department, phone: +49 (0) 621 486 1896



CAUTION

For your general safety, always keep a distance of one metre from the fusion site during the fusion process.

At the end of the fusion time, the fusion unit can be switched off and the fusion cable removed. Remove the UNITOP clamping device as soon as you can after the end of the cooling time (CT) (see Table 6).

d ₁	ASA UNI: Cooling time in minutes after the end of the fusion time up to
	Removal of the UNITOP clamping device. Tapping of unpressured pipes
630 - 900	20

Table 6

NOTICE

The cooling time, CT, is stated on the barcode of the ASA UNI spigot saddle.

NOTICE

Failing to observe the clamping or cooling period can cause the fused joint to leak!

10.5 Removing the clamping unit UNITOP

Undo the spindle nut using the ratchet and turn it until the crossbar is in its lower position. When doing this, secure the clamping unit by holding it firmly and remove the clamping belt from the crossbar (**see Figure 59**).

NOTICE

Secure the clamping unit so that it does not fall onto your feet!

Then remove the clamping unit from the spigot of the ASA UNI spigot saddle (**see Figure 60**) and put the clamping unit back in the transport box.

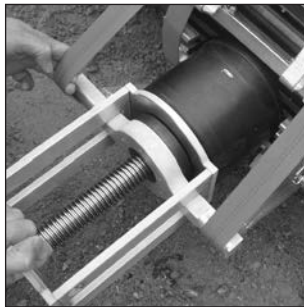

Figure 59

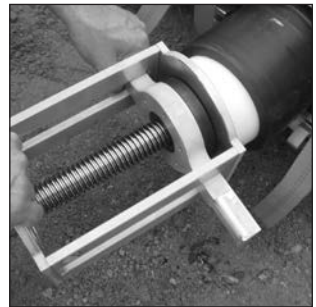

Figure 60

Undo the bottom belt on the pipe, by undoing the belt ratchet and then pull the clamping plate over the spigot of the ASA UNI spigot saddle (**see Figure 61**).

CAUTION

Risk of injury! When used incorrectly, it is possible that the lock of the ratchet can come off and may recoil into the user's hand.

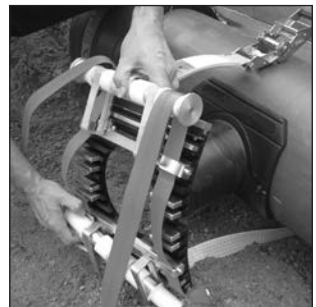

Figure 61

Place the unit dry and clean in the transport box.

10.6 Tapping

Note the processing specifications in the FRIATOOLS operating instructions clamping unit UNITOP and the drilling device FWAB ASA.

Before tapping pipes operating under pressure, please contact our application engineering department, tel.: +49 621 486-1896.

11. Installing the FRIAFIT connecting spigot ASA MULTI

The FRIAFIT connecting spigot ASA MULTI (see Figure 62) is designed to connect HDPE service pipes or SDR 17 d 160 side branches to the clay or concrete pipes in Table 7.

Table 7

Sewer pipe Clay: standard (N) and high load series (H) according to EN 295 Concrete according to EN 1916	Connecting spigot PE 100 / SDR 17 according to EN 12666 d = 160 / DN 150
Clay DN 250 N	ASA MULTI DN 250
Clay DN 250 H	
Clay DN 300 N	ASA MULTI DN 300/350 DN 250/300
Clay DN 300 H	
Clay DN 350 N	
Clay DN 350 H	
Concrete DN 250	
Concrete DN 300	

The required assembly tool (order no.: 682660, **see Figure 63**) is not delivered with the ASA MULTI.

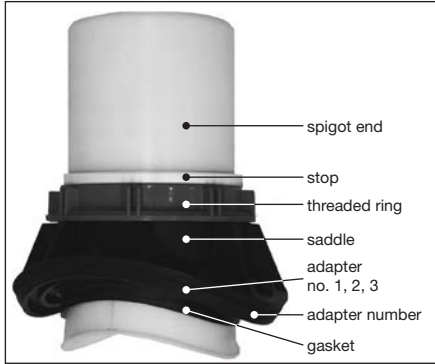

Figure 62



Figure 63

11.1 Tapping the main line

The clay or concrete pipe is tapped with the usual core drills fitted with a standard tapping bit of $d_{AB} = 172$ mm.

Using a suitable core bit (**see Figure 64**), cut out a circular hole where the FRIAFIT connecting spigot ASA MULTI is to be fitted on the main line.

A tight connection is obtained when you observe the following:

- The drill must be vertical to the pipe axis for a circular hole.
- The drilling machine must be mounted securely on the pipe.
- The tapped hole must have a diameter of $d_{AB} = 172^{+2}$ mm.



Figure 64



DANGER

Observe the operating instructions issued by the manufacturer of the tool.

Danger of injury from the core bit! Danger of injury from shards and sharp edges! Wear suitable goggles and protective gloves. After tapping, clean the edges of the cut hole. Examine the hole for damage, e.g. chipping or uneven edges. These may cause leaks at the connection.

NOTICE

The surface of the cut edge may have to be treated according to the pipe manufacturer's instructions.

11.2 Installing the FRIAFIT connecting spigot ASA MULTI

It may have to be adjusted to the pipe type.

By replacing the adapter on the spigot, you can adjust the connecting spigot ASA MULTI to the material and outer diameter of the main pipe (see Table 6, Figure 65a + b).

Loosen two screws on the saddle to detach the adapter (see Figure 65a + b).

To replace the adapter, consult the instruction leaflet.



Figure 65a

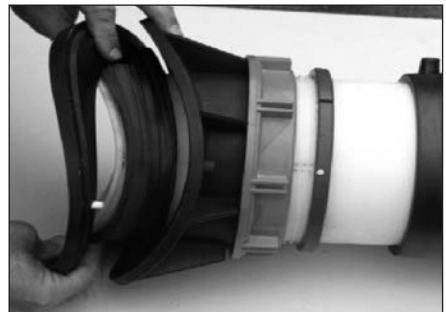

Figure 65b

Table 8:

Sewer pipe	Connecting spigot d ₂ = 160	Adapter No.	Remarks
Clay DN 250 N	ASA MULTI DN 250	2*	Ready to fit
Clay DN 250 H		3*	Adapter 2 exchanged for 3
Clay DN 300 N	ASA MULTI DN 300/350 - CL DN 250/300 - CON	1*	Ready to fit
Clay DN 300 H		1*	Ready to fit
Clay DN 350 N		none	Detach adapter
Clay DN 350 H		none	Detach adapter
Concrete DN 250		1*	Ready to fit
Concrete DN 300		none	Detach adapter

*No. marked on adapter

Insert the ASA MULTI spigot at right angles through the exact centre of the tapped hole until the saddle lies without any gaps on the main pipe (see Figures 66, 67, and 68).

Use the assembly tool (see Figure 69) to tighten firmly the threaded ring on the ASA MULTI. Make sure that the saddle lies without any gaps on the main pipe.

NOTICE

For assembling the ASA MULTI use the assembly tool ASA MULTI MS!



Figure 66



Figure 67



Figure 68

Pay attention that the saddle fitted without any gap on the main pipe and that the distance between stop and threaded ring is $25 \pm 2\text{ mm}$ (see Figure 70).

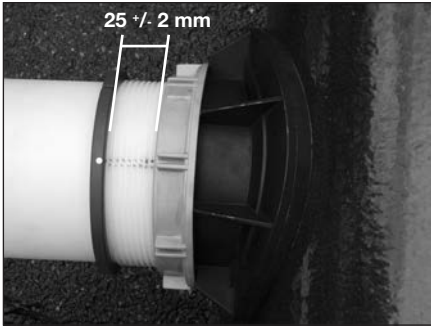

Figure 70



Figure 69

11.3 Fitting the connecting line

Use a FRIAFIT coupler AM or a FRIAFIT sewage bend ABM to connect the PE service line to the PE spigot on the FRIAFIT ASA MULTI.

Please observe the processing instructions under Section 4.

12. FRIAFIT Transition fittings UKG, USTZ, branches, sewage bends (spigot fittings) and transition fittings AMKG

are HDPE fittings which are joined to FRIAFIT Fittings in the same way as HDPE pipes (**see section 4**).

The fusion zones must be free from contaminations, in particular if lubricants, which might get into the fusion zone, are used for the installation of slip-on couplers.

Specific standards, e.g. with regards to authorised diameter tolerances and insertion depths, as well as installation instructions, must be observed for the connection of materials.

13. Installing the FRIAFIT FIXBLOC

The FRIAFIT FIXBLOC is used for absorbing axial thrust and tensile forces, which may be at work in the following applications on a HDPE pipe system;

- as a protection against indentation or extraction during pipe reconstruction
- as a protection against extraction at fixed points, e.g. for over ground pipe installations,
- for fixing sink weights, e.g. for under water pipelines.

NOTICE

Make sure before starting work that you have the following tools and equipment in perfect working order:

- For assembling with tensioning belt: belt (width and length see page 56)
- For assembling with clamping unit: FRIATOOLS clamping unit FIXBLOC
- Standard fusion equipment

For specific information about the processing areas for the FRIAFIT FIXBLOC, please contact our application engineering department, tel.: +49 621 486-1896.

Where the operating conditions are different, then please contact also our application engineering department to determine whether the FRIAFIT FIXBLOC is the right product to use.

13.1 Fitting the FIXBLOC by using a tensioning belt

Prepare the pipe and FIXBLOC, measure and mark the fusion zone on the pipe surface, remove oxide layer from the pipe and also clean the fusion zone (pipe surface and fusion zone of the FIXBLOC).

13.1.1 Positioning the FIXBLOC on the pipe

Position the FIXBLOC on the prepared pipe surface, Loop the belt round the pipe and thread the belt into both flaps of the FIXBLOC (see **Figure 71**).

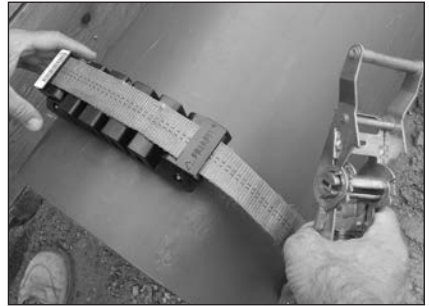

Figure 71

The FIXBLOC can also be used in multiple applications, use of several FIXBLOCs round the pipe.

Guide the end of the belt into the belt ratchet and fix the FIXBLOC onto the pipe by operating the belt ratchet (see **Figure 72**).

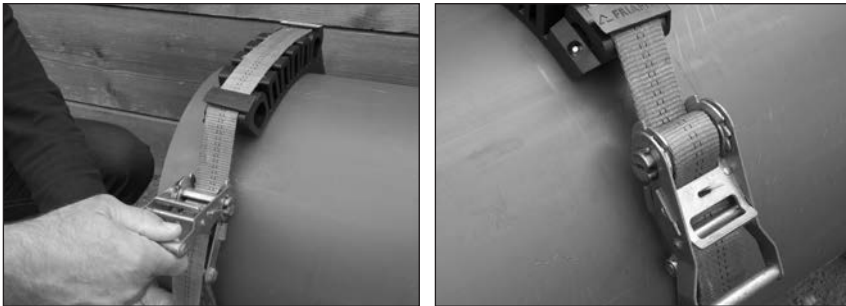

Figure 72

CAUTION

Risk of injury! Once the installation is complete, the clamping lever of the ratchet must be locked in a closed position (see Figure 72)

CAUTION

**Belt is under tension!
If the belt fails, this can lead to injuries.**

NOTICE

Selecting the belt!

Use belts with a belt width of 50 mm and a minimum length of approx. 3.5 times the pipe diameter. When used in multiple applications the belt length must be adjusted accordingly.

The FIXBLOC must now be positioned on the pipe with no gaps (see Figure 73).



Figure 73

NOTICE

Check the position of the FIXBLOC and correct, if necessary. Also check that there are no gaps between the FIXBLOC and the pipe (see Figure 73)!

13.1.2 Carrying out of fusion

Connect the fusion cable from the fusion unit with the fusion contacts of the FIXBLOC (see Figure 74) and read the fusion parameters which are in the barcode using the scanner or barcode reader.



Figure 74

NOTICE

The barcode which is required for the fusion process is affixed on a flap on the FIXBLOC (see Figure 75)!



Figure 75

Start fusion. Note the operating instructions for the FRIAMAT fusion unit.

CAUTION

For your general safety, always keep a distance of one metre from the fusion site during the fusion process.

At the end of the fusion time, the fusion unit can be switched off and the fusion cable can be removed.

During the cooling time, the FIXBLOC must still be clamped. At the end of the cooling time, the belt can be removed.

NOTICE

Observe the cooling time! Please note the CT information on the barcode!
If the cooling time is not observed, then the anchor force of the FIXBLOC may be significantly reduced.

13.1.3 Removing the tensioning belt

Undo the strap by opening the belt ratchet. Take the belt off the FIXBLOC.

13.2 Fitting the FIXBLOC using the clamping unit FIXBLOC FWFB

If it's not possible to fit the FIXBLOC with a tensioning belt, e.g. because the pipe circumference is not accessible, the mounting must take place with the FRIATOOLS clamping unit FIXBLOC FWFB.

NOTICE

It is essential that you follow the steps in the sequence as described.

Prepare the pipe and FIXBLOC in accordance with the general assembly requirements, see also the FRIATOOLS operating instruction FIXBLOC FWFB, measure and mark the fusion zone on the pipe surface, remove oxide layer from the pipe and also clean the fusion zone (pipe surface and inner fusion zone of the FIXBLOC).

13.2.1 Positioning the FIXBLOC on the pipe

NOTICE

Before fitting the fixing plate, read the fusion parameters which are in the barcode using the scanner or barcode reader. Once the fixing plate is fitted on the FIXBLOC, then the barcode is obscured and can no longer be easily accessed by the scanner or barcode reader.

Fit the fixing plate onto the FIXBLOC (see Figure 76).



Figure 76

Make sure that when fitting the fixing plate on the FIXBLOC, the two guide rails on the fixing plate are positioned on the two outer bars of the FIXBLOC (see **Figure 77**).



Figure 77

Position the FIXBLOC with the pre-fitted fixing plate onto the surface of the pipe.

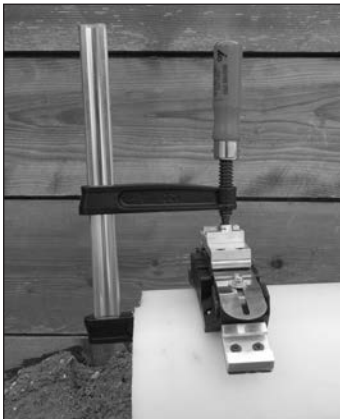

Figure 78

Then fit the first of the three screw clamps in the centre of the fixing plate. For easy fitting of the screw clamp, a guide is mounted on the fixing plate (see **Figure 78**).

By turning the handle on the screw clamp the FIXBLOC will be positioned firmly on the pipe.

NOTICE

After fitting the first screw clamp check that the FIXBLOC is in the correct position on the pipe!

Then fit the two remaining screw clamps on the outer positions of the fixing plate (see Figure 79).



Figure 79

Guides are mounted on the fixing plate to help with fitting the screw clamps on both the outer fitting positions (see Figure 80).

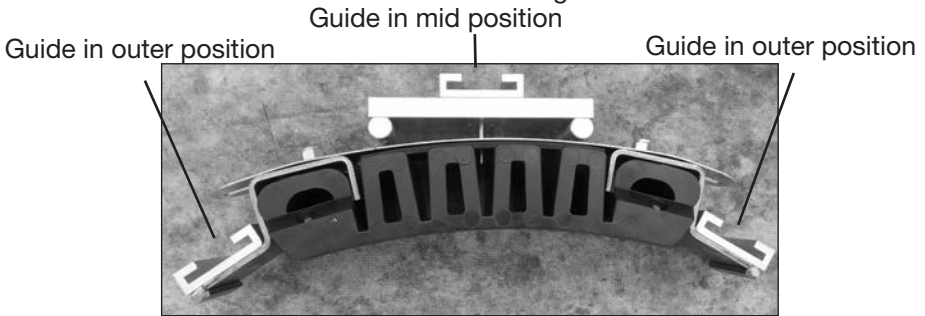

Figure 80

By turning the handles with a ratchet or socket wrench the FIXBLOC is positioned on the pipe surface with no gaps (see Figure 81).

NOTICE

When tightening the two outer screw clamps, make sure that the centre screw clamp does not become loose. Re-tighten these if necessary.



Figure 81

NOTICE

When fitting the outer screw clamps, make sure that you have the highest feed rate for the threaded spindle (see Figure 82)! This guarantees that the larger gaps between FIXBLOC and the pipe can also be bridged.

The FIXBLOC is fitted correctly on the pipe, when both external guides are positioned on the pipe (see Figure 83).

The FIXBLOC must now be positioned on the pipe with no gaps (see Figure 84).



Figure 84

NOTICE

Check the position of the FIXBLOC and correct, if necessary. Also check that there are no gaps between the FIXBLOC and the pipe (see Figure 84)!

13.2.2 Carrying out of fusion

Connect the fusion cable from the fusion unit with the fusion contacts of the FIXBLOC (see Figure 85). The fusion parameters which are in the barcode must be read using the scanner or barcode reader before fitting the fixing plate.

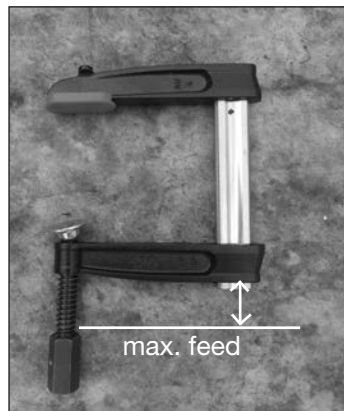

Figure 82



Figure 83

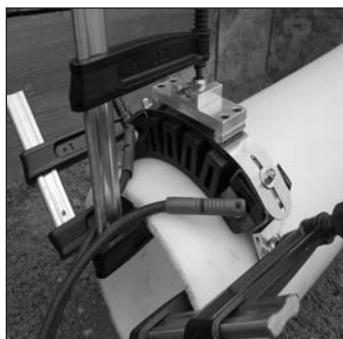

Figure 85

Start fusion. Note the operating instructions for the FRIAMAT fusion unit.



For your general safety, always keep a distance of one metre from the fusion site during the fusion process.

At the end of the fusion time, the fusion unit can be switched off and the fusion cable can be removed.

During the cooling time, the FIXBLOC must still be clamped. At the end of the cooling time, the clamping unit FIXBLOC FWFB can be removed.

NOTICE

**Observe the cooling time! Please note the CT information on the barcode!
If the cooling time is not observed, then the anchor force of the FIXBLOC may be significantly reduced.**

13.2.3 Removing the clamping unit FIXBLOC FWFB

Remove the clamping unit FIXBLOC FWFB by turning the handles on the screw clamps of the FIXBLOC. Once the screw clamps have been opened they can be removed from the guide rails on the fixing plate.



The fixing plate is under pressure, there is a risk of injury when opening the screw clamps.

Place the dry, clean components of the clamping unit FIXBLOC FWFB in the transport box.

Further operating and assembly instructions are available:

- FRIALEN®-Safety Fittings for house connections and distribution pipes up to d 225
- FRIALEN®-Large Pipe Technique for laying large pipes and relining pipe networks
- FRIAMAT® Fusion Units
- FRIATOOLS® Scraper Tools
- FRIATOOLS Clamping Units
- FRIATOOLS Clamping and Drilling Unit

14. Updates of assembly instructions

These technical statements are checked regularly in terms of up-to dateness. The date of the recent revision is specified on the document.

Visit www.friafit.com, in the left navigation menu you will find the submenu "Downloads". Here you will be able to read and even print out up-to-date operating instructions (pdf file). We also would be pleased to send them to you.

Great service!

We leave you with our products not alone - we combine our technical solutions with competent and great services.

This includes:

- ▲ training
- ▲ advice on the site
- ▲ demonstrations
- ▲ construction site instructions
- ▲ construction site service
- ▲ mobile fusion unit service
- ▲ rent service for our FRIATOOLS equipment



Contact our hotline
+49 621 486-1896

Aliaxis

FRIATEC GmbH
Technical Plastics Division
P.O.B. 7102 61 - 68222 Mannheim - Germany
Tel +49 621 486 2238 - Fax +49 621 479196
info-frialen@friatec.de

www.friafit.com

